



**DUNCAN**

*Built to work.*

---

# FOR GREAT PASTURE AND CROP YIELD.

---

**CHOOSE DUNCAN ENVIRO DISC DRILLS.**



# Giltrap Ag are proud manufacturers of Duncan

Experience tells us that time is the scarcest commodity on your farm. That's why at Giltrap Ag, we focus our energy on understanding the mechanics of your daily farm routines to engineer solutions that are in sync with your operations. We're committed to bringing you only the best quality machinery that meets the crop management practices of modern farming.



Duncan's world-best technology is helping farmers produce some of the world's highest yielding pasture for all stock grazing applications - delivering improved milk output, greater returns from sheep and beef, and improved crop yields. From their origins designing and building swamp ploughs for breaking in land, to supporting efficient pasture and crop management practices of modern-day farming, Duncan machinery has always taken the lead.

We understand farming conditions, so all Duncan products can be relied upon to deliver reduced downtime, lower maintenance costs and longer machine life, whatever the demands placed on them.

**Choose Duncan to increase your yield and returns.**



 **GILTRAP AG**  
ENGINEERED PERFORMANCE

  
GILTRAP

  
DUNCAN

# Why choose a disc drill?

Direct drilling. Better for your soil, better for your bottom line.

With Duncan's unrivalled ability to follow ground contour and deliver seed evenly on all terrain, we are helping farmers, contractors and growers to produce some of the highest yielding pastures and crops in the world. Duncan Enviro Disc Drills will perform equally well in cultivated ground or direct drilling into virgin ground, existing pasture or crops. They are generally a better option for direct drilling into stony ground than tine drills because a disc drill doesn't pull stones to the surface and will usually leave a neater finish than a tine drill, particularly in zero tillage situations.



### Features:

- Excellent at cutting through trash and stubble
- Cuts a clean slot leaving a very neat and tidy finish
- Fluted and scalloped discs minimise hair pinning
- Greater ability to follow contour of the ground to deliver seed evenly on all terrain
- Suited for rocky conditions without bringing rocks to the surface
- In most set-ups it will sow the fertiliser slightly deeper than the seed
- Electric drive is available on all models
- Available as double or triple disc configurations

### Economic and soil conservation benefits of direct drilling:

- Reduces fuel use by 50-75%
- Reduces labour by up to 60%
- Reduces time in tractor seat by up to 50%
- Equipment breakages in stony conditions are rare compared with traditional tillage methods
- Reduces soil erosion caused by wind and water
- Reduces soil compaction
- Reduces soil moisture loss
- Reduces irrigation frequency
- Enables earlier grazing of new pastures due to the ground being left relatively intact
- Stones are not brought to the surface

**Available in either double or triple disc configurations, there's a Duncan Enviro Disc Drill that is right for your application.**

In both the double and triple disc configurations the seed and fertiliser is dropped into a narrow V slot. Our fluted opening disc creates a seed bed with loose soil in the slot, and following press wheels close and gently compress the slot for improved seed to soil contact and moisture retention, promoting germination and rapid root development.

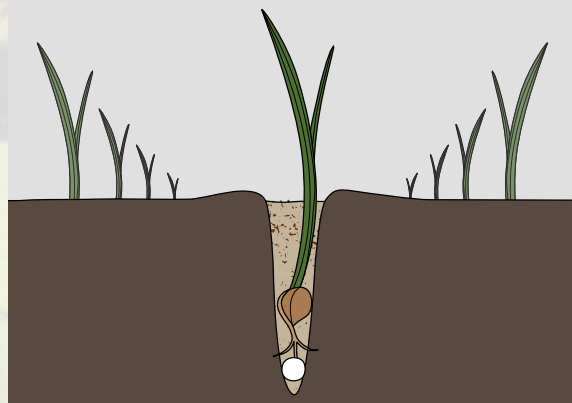

# World class technology

Duncan Enviro disc drills are designed and manufactured with proven disc configurations for optimum ground penetration and preparation, accurate seed metering and delivery systems, and intuitive high-tech control systems for easy job configuration, calibration and monitoring.

Our advanced technology features have been engineered to maximise your productivity, making every minute count by providing unrivalled durability, efficiency and performance.



## Vineyard & Orchard Seeder Disc Technology

### Features

- 310mm diameter discs are easier to force into hard ground commonly found in vineyards and orchards
- Two plain discs work side by side to open up a slot and place the seed evenly
- A press wheel closes the slot to ensure a good seed soil contact
- The press wheel helps to trap moisture by closing off the slot
- The dragbar units are spring loaded to allow individual units to roll up over stones
- The discs are excellent for cutting up prunings that may be lying across the ground

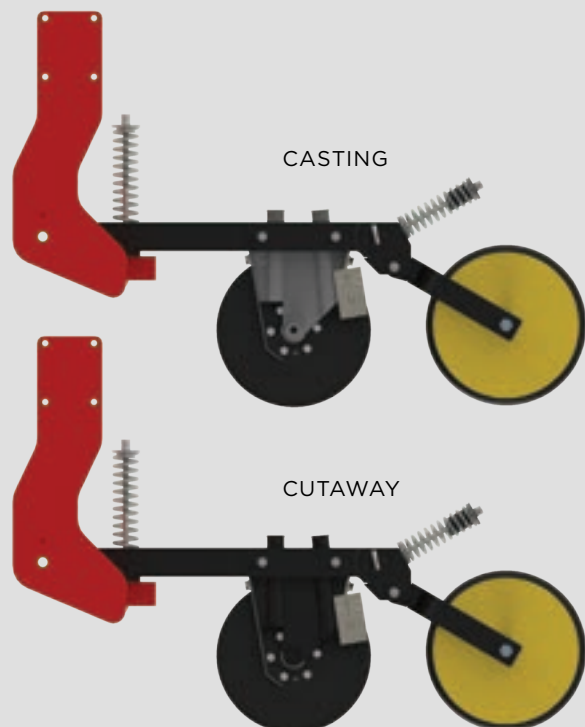

Available on the following models:  
Vineyard Seeder, Orchard Seeder

# Double Disc Technology

## Features

- Lower investment cost than a triple disc drill and lower maintenance costs with less wearing parts
- Large 380mm diameter heat treated discs work hard and have a long life
- A scalloped disc leads 30mm ahead of a plain disc to cut through trash and open up a rough slot creating tilth for good germination. The (full assembly) leading scalloped disc removes the need for an opening disc
- The plain disc holds the slot open to place the seed and the fertiliser into the slot
- The spring loaded jump assembly creates downward pressure but also allows the discs to ride up and over rocks and obstacles
- An optional press wheel or harrows close the slot to help with seed to soil contact and traps moisture

Available on the following models:  
DD30, DD35, DD45, DD50, DD55

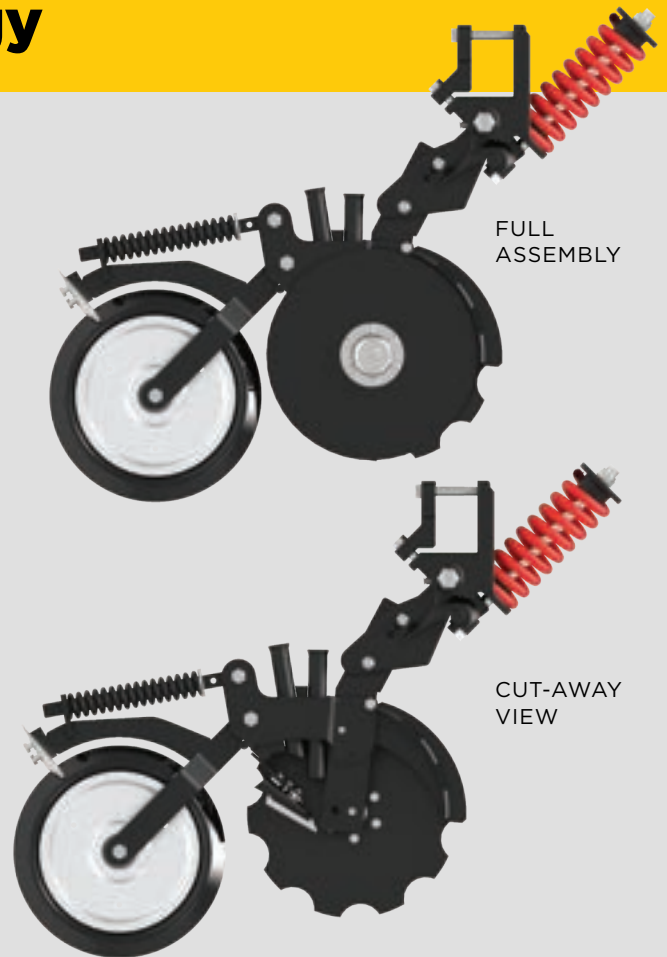

# Triple Disc Technology

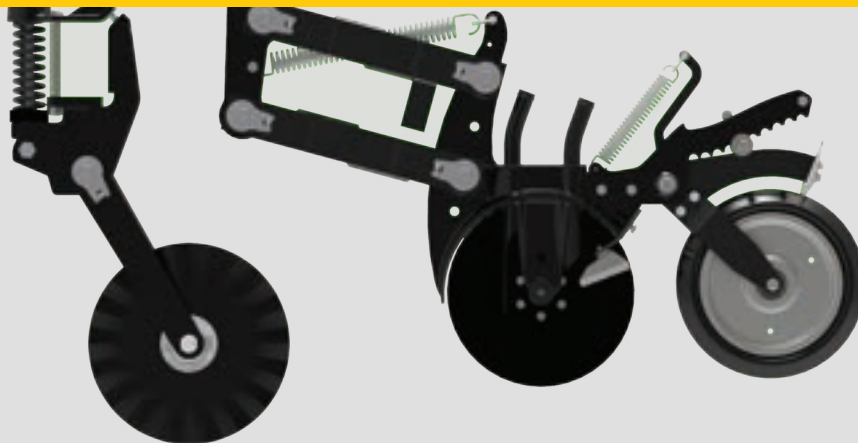

## Features

- Independent 400mm diameter fluted opening disc, mounted well forward of each double disc assembly allowing the drill to break into extremely hard ground and cut trash
- The double disc setup follows directly behind the opening disc, holding the slot open while the seed and fertiliser is placed into the slot
- The sowing depth is accurately controlled by a following press wheel which also closes the slot. The depth setting is individually set on each press wheel
- A parallelogram system with 400mm of vertical travel gives the individual double disc units superb contour following for constant control of seed and fertiliser depth

Available on the following model: ATD30

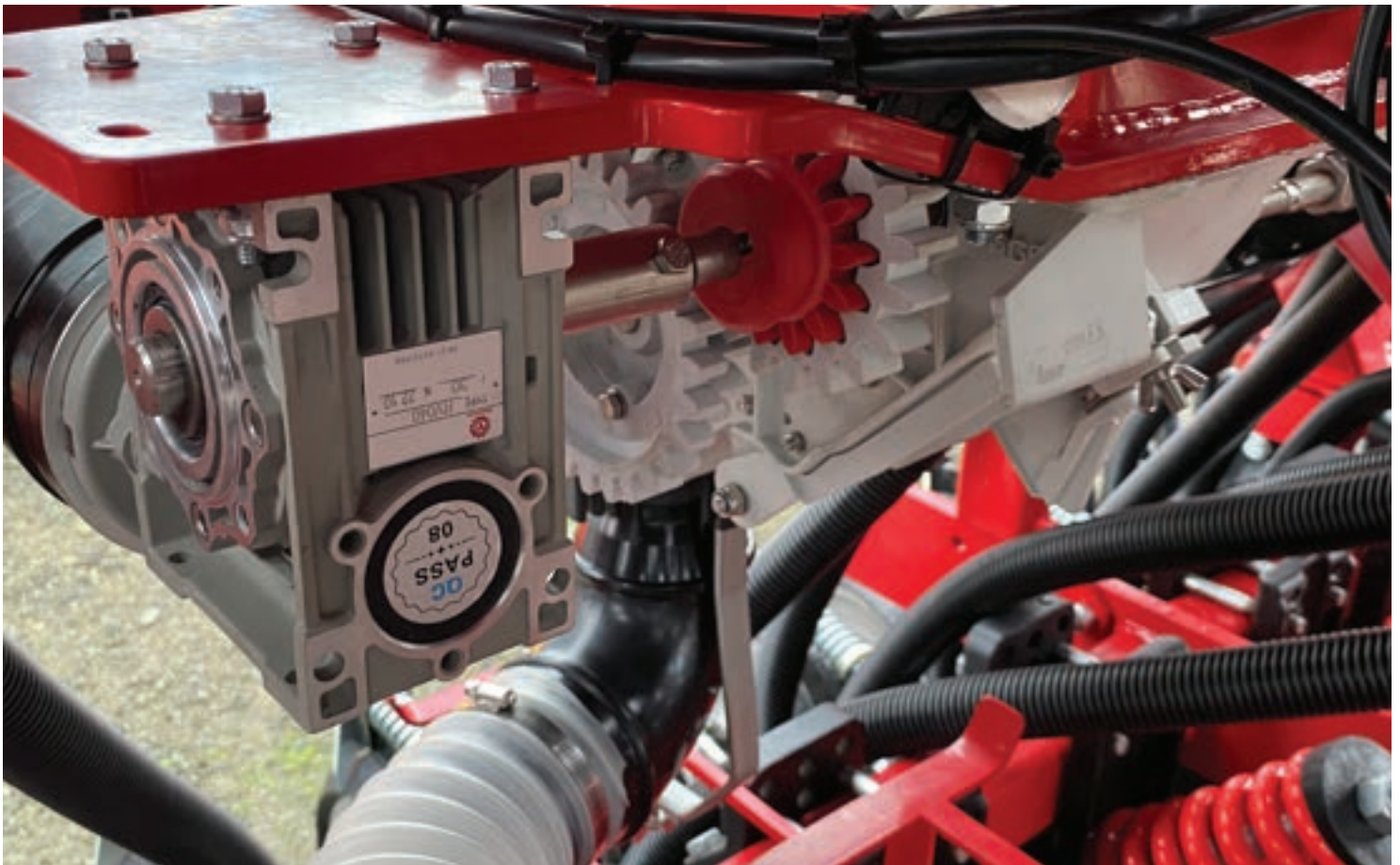

## Duncan Touchscreen Electric Drive

**Our high torque electric drives and touchscreen electronic rate control are accurate, simple to use and give the user instant feedback about the operating state of the drill.**

### Features

- Precision and flexibility to vary planting rates electronically
- Fingertip calibration adjustments
- Touchscreen control for turning planting on and off
- Checks drilling rates and areas planted in real time
- High torque electric motor drives and reduction gearboxes
- Visual and audible warnings of drilling rates and bin levels
- Transfer of job data between the field and the office using a USB port
- Capability to add a GPS for coverage mapping, record keeping and proof of planting
- Can connect with WIFI to the Duncan Calibration App
- Can be fitted as an ISOBUS system

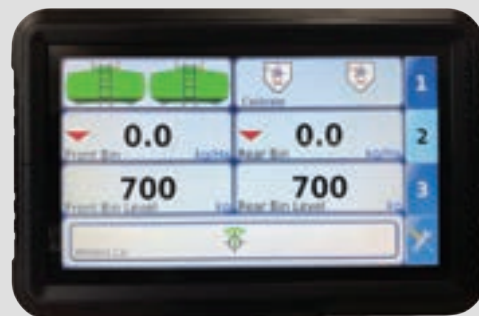

*Standard on DD45, DD50 and DD55. Available as an option on all other models.*



## Air Seed Distribution

**Our air distribution system consists of a high-speed hydraulically powered fan, which blows air through a Venturi system and distributor heads out to the sowing discs.**

### Features

- The fan has an oil cooling radiator mounted to the suction inlet to warm and dry the air, minimising blockages in humid conditions
- The seed is blown to the ground rather than relying on gravity, chatter and hose vibration ensuring excellent air distribution on hills, uneven terrain or smooth, worked out ground
- Large air seed hoppers are easy to fill, and air seeders can be wide but easily folded for transport



*Standard on DD30, DD35, DD45, DD50, DD55, ATD30.*



## Gravity Seed Distribution

**Our reliable metering system has been utilised on Duncan Drills for years. It is easy to calibrate and use, requires no tractor hydraulics to run it and it is incredibly accurate due to the seeds being metered from individual outlets for each run, with sowing rates of less than 1kg/hectare achievable.**

Seed and fertiliser is stored in boxes above the drilling discs and drops into the metering peg roller system for each run, with paired large and fine seed wheels, and flow control flaps to handle different seed sizes and sowing rates.

The metered seed and fertiliser then drops down flexible hoses to be planted. The calibration tray collects the seed when calibrating and is used to cover the metering units to stop any foreign matter entering the metering unit in operation.

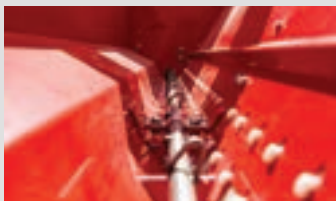

Stainless steel agitator shaft eliminates compaction and bridging, and improves the flow of fertiliser and seed



Adjustable flaps control the outlet flow

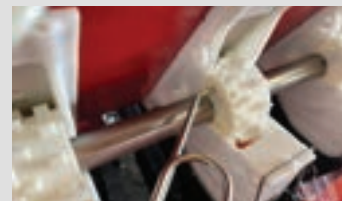

Dual large and fine metering wheels allow for a wide range of seed types and fertilisers



Mechanical gearboxes or high torque DC motor drives are easily adjustable and have infinitely variable sowing rate control



Shutter slides at the top of each metering device are used to control the seed flow and can also be used to shut off a seed row if required



## Calibration App

**No more fumbling through manuals or using the tractor's in-cab controller. Take your drilling operations to the next level of productivity with seed drill calibration at the touch of your finger. Use the Duncan Drill Calibration app on your phone for easy and accurate job configuration and calibration of any Duncan Enviro Disc drill.**

### Features

---

- The Duncan Drill Calibration app contains step-by-step user guides for making calibration and mechanical adjustments to your drill
- Calibrate multiple machines with the app, and get every operator set up so they can do calibrations from their own phone
- Calibrating a ground drive drill with seed or fertiliser will display the required mechanical settings
- Connect wirelessly to a Duncan E-Drive drill to set up the sowing rates and run calibrations while you are right beside the drill

**TO CHECK COMPATIBILITY,  
CONTACT YOUR DEALER.**

### INSTALL THE APP

GOOGLE PLAY  
DOWNLOAD



APP STORE  
DOWNLOAD



# Choosing a Duncan Enviro Disc Drill

Which Duncan Enviro Disc Drill is right for you?

---

## FOR HORTICULTURE OR VITICULTURE?

Vineyard Seeder, Orchard Seeder

**14**

---

## LOOKING FOR PERFORMANCE ON A BUDGET?

Enviro DD30, 35

**15**

---

## LARGE SCALE CONTRACTOR?

Enviro DD45, 50, 55

**16**

---

## WANT THE ULTIMATE TRIPLE DISC?

Enviro ATD30

**18**

---

## WANT AN AFFORDABLE FARMER SPEC'D TRIPLE DISC?

Enviro 740

**20**

---

## NEED A FOLLOWING ROLLER, HARROWS, CRANE OR AIR HOPPER?

Accessories

**22**

---

# Disc Drill Feature Comparison Chart

MODELS	Vineyard Seeder Orchard Seeder	DD30 DD35	DD45 DD50 DD55	ATD30	Enviro 740
<b>FEATURES</b>					
Gravity feed	●				●
Air feed		●	●	●	
Double or dual box/hopper	●	●	●	●	●
2PTL hitch			●	●	
Drawbar hitch		●			●
3PL hitch	●				
Fixed frame	●	●		●	●
Folding frame			●		
Double disc	●	●	●		
Triple disc	○			●	●
Spring head assembly		●	●		
Drag arm assembly	●				●
Parallelogram assembly				●	
Press wheels	○	○	○	●	●
Depth control - press wheels				●	●
Depth control - wheel arms	●	●	●		
Powder coated finish	●	●	●	●	●
Stainless steel agitator shafts in box/hopper	●	●	●	●	●
3 year structural warranty	●	●	●	●	●
3rd seed box/hopper - seeds		○	○	○	○
4th hopper - pesticides		○	○	○	
Tine harrows		○	○		
Uni-Roller		○			
Hectaremeter kit	○	●			●
Mechanical drive	●	●			●
Electric drive	○	○	●	●	○
ISOBUS	○	○	○	○	○
Stainless steel box/hopper	○	○	○	○	○
Heat exchanger kit		●	●	●	
Hydraulic ram on drawbar		○			
Mounted hydraulic crane		○	○	○	
Seed level indicator in box/hopper	○	○	●	●	○
Camera in hopper	○	○	○	○	○
Wider tyres		○			
Bin extension kit		○			○
Rear tow bar		○	○	○	○
Jack stand on drawbar		●			●
Drop down stand	●		●	●	
Visibility & lighting kit		○	○	●	●

● Standard feature

○ Optional feature

# Orchard Seeder

Designed specifically for planting under the canopy in horticultural applications, the 3 point linkage hitch makes it easy to get in and out of the rows at the headlands.



**Seed size:**  
Small to large



**Operation size:**  
Up to 100Ha

## Features

- Large diameter discs to run over small branches or prunings on the ground without dragging them
- Peg tooth roller metering units for sowing a variety of seeds and fertilisers
- Rear foot board
- Weather skirts to protect the outlet units in damp conditions
- Weigh kit to weigh seed and fertiliser
- Twin boxes
- Simple calibration system
- Agitator shaft prevents seed compaction and vees in the bottom of boxes to improve seed flow
- Press wheels are optional



## Dimensions & Capacities

	Orchard Seeder 11 Row	Orchard Seeder 14 Row
Sowing width (mm)	1650	2100
Overall width (mm)	1910	2188
Overall length (mm)	1820	1800
Overall height (mm)	1480	1480
Row spacing (mm)	150	150
Box capacity (l per box)	130	150

# Vineyard Seeder

This double disc seeder is specifically designed for planting between rows in vineyards, and will sow into the rough, rocky conditions that vineyard soil is known for, establishing a cover crop in one pass.



**Seed size:**  
Small to large



**Operation size:**  
Up to 100Ha

## Features

- Large diameter discs to cut through trash
- Peg tooth roller units for sowing a variety of seeds and fertilisers
- Rear foot board
- Weather skirts to protect the outlet units in damp conditions
- Weigh kit to weigh seed and fertiliser
- Twin boxes
- Simple calibration system
- Agitator shaft prevents seed compaction and vees in the bottom of boxes to improve seed flow
- Press wheels are optional



## Dimensions & Capacities

	Vineyard Seeder 10 Row
Sowing width (mm)	1800
Overall width (mm)	1835
Overall length (mm)	1610
Overall height (mm)	1520
Tare weight with press wheels (kg)	873
Row spacing (mm)	180
Box capacity (l per box)	209



# Enviro DD30/35

The fixed frame Enviro DD30 and DD35 have a double disc setup with a unique offset scalloped disc which leads a plain disc to open up the seeding slot and give good ground penetration. These machines will handle trash and deliver seed evenly on all terrain. An extensive list of options including press wheels make these very versatile drills.



**Seed size:**  
Small to large



**Operation size:**  
All

## Features

- Accurate and versatile seed metering system
- Large capacity split hopper
- Double disc with ground following ability
- Large loading/access platform with safety rails

## Dimensions & Capacities

	23 Row 3 Metre	27 Row 3.5 Metre
Sowing width (mm)	2875	3375
Overall width (mm)	3070	3570
Overall height (mm)	4100	4100
Working height (mm)	2300	2300
Transport height (mm)	2500	2500
Unladen weight - with press wheels fitted (kg)	2700	3000
Row spacing (mm)	125	125
Hopper capacity (L per side)	700	700



Scalloped disc and plain disc



Press wheel following the double discs



Metering distribution unit - high and low ratio settings



# Enviro DD45/50/55

These Enviro DD models are folding versions of the DD30. Perfect for large scale farmers and contractors. These machines are easy to set up and operate, and the folding frame ensures that it is wide at work and narrow to transport. An extensive list of options including press wheels make these very versatile drills.



**Seed size:**  
Small to large



**Operation size:**  
300Ha plus

## Features

- Large, easy access loading platforms and safety rails
- Unique scalloped disc creates tilth and leads the plain disc which opens up the slot
- Duncan touchscreen electric drive system with GPS speed sensing
- Accord type metering and air system with hydraulic fan
- Wide flotation transport wheels
- Automatic wing locks when in transport
- Hydraulically controlled downward pressure on the wings
- Easy sowing depth adjustment
- Bin level sensors in hoppers
- Large 1200 litre hoppers with internal distributor heads

## Dimensions & Capacities

	DD45 32 Run	DD45 38 Run	DD50 34 Run	DD50 40 Run	DD55 36 Run	DD55 44 Run
Sowing width (mm)	4800	4750	5100	5000	5400	5500
Transport width (mm)	3100	3100	3100	3100	3100	3100
Working width (mm)	4920	4920	5320	5320	5820	5820
Overall length (mm)	5225	5225	5225	5225	5225	5225
Working height (mm)	2940	2940	2940	2940	2940	2940
Transport height (mm)	3265	3265	3265	3265	3265	3265
Unladen weight (kg)	4960	5172	4800	5050	4950	5200
Row spacing (mm)	150	125	150	125	150	125
Hopper capacity (L per side)	1200	1200	1200	1200	1200	1200
Recommended min tractor HP	160	160	160	160	160	160

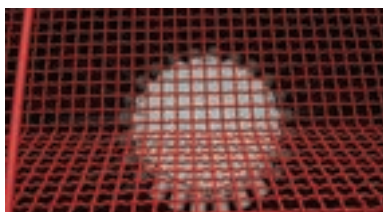

Distributor head & mesh screen in the hopper



Hydraulic fan with splitter



2 point hitch tow coupling



Depth adjustment on rams



Folded for transport



Heat exchanger



# Enviro ATD30

The Enviro ATD30 is the ultimate triple disc, multi-purpose seeder. It features opening Turbo Tilth discs followed by large diameter, narrow “V” spacing double discs for excellent ground penetration. The double disc and press wheel assemblies are mounted on ground following parallelogram systems. Tailor to your needs by adding a steering axle, brakes, stabilising wheels, bin cameras and extra hoppers for small seeds and pesticides.



**Seed size:**  
Small to large



**Operation size:**  
300Ha plus

## Features

- Duncan touchscreen electric drive system with GPS speed sensing
- Stainless steel Amazone metering units with exchangeable cartridges for sowing a variety of small to large seeds and fertilisers and are very easy to calibrate
- Optional ISOBUS or ISOCAN system upgrades for integration to tractor control screens
- Large 406mm diameter Turbo Tilth blades cut slots into the toughest of ground conditions
- Large 400mm plain discs mounted in a narrow “V” penetrate and open up the slots for accurate seed and fertiliser placement
- Depth control press wheels control the sowing height and close the slot, enhancing seed to soil contact.
- Bin level sensors in hoppers
- Large 1300 litre split hoppers
- 500/60-22.5 wide flotation transport wheels
- 2 point hitch tow coupling for easy maneuverability

## Dimensions & Capacities

	25 Row	27 Row
Sowing width (mm)	3100	3100
Overall width (mm)	3100	3100
Overall length (mm)	6100	6100
Working height (mm)	2790	2790
Transport height (mm)	3330	3330
Unladen weight (kg)	6600	6600
Row spacing (mm)	125	115
Hopper capacity (L per side)	1300	1300



Heat exchanger keeps air flow dry



Opening Turbo Tilth disc, double discs on parallelogram & press wheels

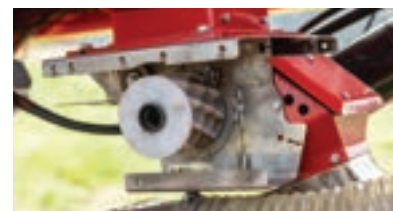

Stainless steel Amazone style metering system in both hoppers



External distributor heads with straight hose runs for good seed flow



Optional rear towbar kit

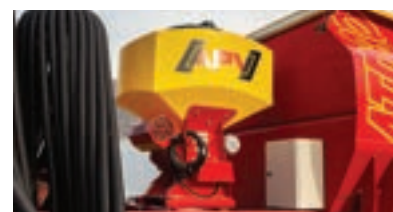

Optional 3rd & 4th hoppers for small seeds & pesticides



# Enviro 740

Solid and rugged construction makes it evident that the Enviro 740 is built to last, and with independent triple disc assemblies for maximum ground contact it's excellent for drilling over undulating ground. Adjustable press wheels control the seed depth over the entire sowing width for enhanced soil to seed contact and increased moisture retention to promote germination.



**Seed size:**  
Small to large



**Operation size:**  
From 100Ha

## Features

- Independent drag arms with triple discs and press wheels for each row
- Easy access front and rear loading platforms with safety rails
- 130mm / 5-1/4" or 150mm / 6 " row spacing options
- Weather skirts cover seed / fertiliser outlets
- Depth control via the wheel legs and the press wheels
- Stainless steel agitator shafts in boxes
- Accurate and reliable gearbox
- Peg roller seed / fertiliser distribution units
- Weigh kit with electronic scales and hectaremeter
- Sows a variety of seeds and fertiliser
- Free-wheeling hub and safety chains for transport
- 15/17/19/21/23/26 row models
- Tractor grip tyres

Dimensions & Capacities	15 Row	17 Row	19 Row	21 Row	23 Row	26 Row
Weight (kg)	2730	3080	3485	3850	4200	4725
Sowing width (mm)	2250	2210	2850	2835	3450	3380
Overall width (mm)	3284	3284	3884	3884	4644	4644
Overall length (mm)	3750	3750	3750	3750	3750	3750
Height (mm)	1520	1520	1520	1520	1520	1520
Box capacities (l)	349	349	443	443	538	538
Row spacing (mm)	150	130	150	130	150	130

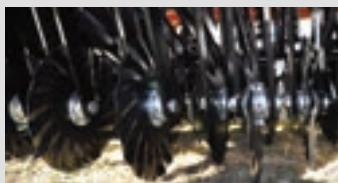

400mm opening turbo tilth discs for cutting through heavy trash



Adjustable wheels for closing the slot and controlling the depth



Peg seeder units with large and small seed wheels for most varieties of seed and fertiliser



## Following Tools and Accessories

Achieve superior germination with our range of quality following tools and accessories for your Duncan seed drill.

# Uni-Roller

The Uni-Roller is a following tool for use in direct drilled or worked ground applications. The Uni-Roller comes with new tyres for even compaction, can be water filled for added weight, and is able to be towed on the road.

## Features

- 2.4 metre, 3 metre or 3.5 metre sizes
- Made with new tyres
- Jack stand is standard
- Ability to add water weight
- Fully powder coated finish

## Dimensions

	2.4m	3m	3.5m
Overall width (mm)	2554	3153	3612
Working width (mm)	2390	2990	3448
Height (mm)	623	623	623
Length (mm)	2300	2300	2300
Weight with water (kg)	680	800	915
Weight - unladen (kg)	496	578	652



# Tine Harrows

The ideal and economical following tool after sowing direct or into worked ground. Offering adjustable tension and tine pitch, with transport and work positions. This covering tool will create good seed-to-soil contact.

## Features

- Adjustable tine pitch
- Raises up and down with drill
- Adjustable spring tension
- Adjustable transport/work position
- Replaceable tines
- Powder coated finish

## Dimensions

	1.9m	2.4m	3m	3.5m
Overall width (mm)	1900	2400	3000	3500
Working width (mm)	1900	2400	3000	3500
Weight (kg)	70	80	90	110



## Contour Rollers

The Contour Tyre Roller has two wheels per independent oscillating assembly for the best ground following ability in closing the slots and ensuring good seed-to-soil contact.

### Features

- 2 wheels per oscillating assembly for better ground following ability
- Fully powder coated finish
- Ability to add water weight
- Made with new tyres
- Jack stand
- Hydraulic folding frame for wider than 3.5m models

### Dimensions

	3m	3.5m	5.3m	6m
Overall width (mm)	3000	3660	5560	6280
Transport width (mm)	3000	3660	3000	3000
Height - working (mm)	1030	1030	1150	1150
Height - transport (mm)	-	-	3260	3615
Length (mm)			4050	4050
Qty of tyres	14	20	30	34
Turf tyre		23 x 10, 5-12/12" x 7" Rim		



# APV Seeder

These APV hydraulic or electric air seeding units are suitable as third hoppers on most Duncan drill models. Ideally suited for broadcasting cover crops in the same pass as sowing the main crop.

Dimensions & Capacities	PS 300 M1 Electric fan	PS 300 M1 Hydraulic fan	PS 500 M2 Hydraulic fan
Hopper (L)	300	300	500
Sowing width (m)	1 - 4	1 - 12	1 - 12
Outlets	8	8	8
Weight (kg)	70	93	116
Dimensions (L x W x H cm)	110x77x100	110x77x100	125x80x125
V (through a euro (D) plug)	12V, 25A	12V, 25A	12V, 25A
Control panel	Yes	Yes	Yes
Spreader plates	Yes	Yes	Yes
Fine and coarse seed roller	Yes	Yes	Yes
25m Seed hose	Yes	Yes	Yes
Cable (1.5m) from euro plug to control panel	Yes	Yes	Yes
Cable (6m) from control panel to the APV Unit	Yes	Yes	Yes
8mm Base metal base plate	Standard	Standard	Standard



# APV Slug Bait Spinner

The MDD 100 M1 is ideal for spreading grass seed or slug bait. The working width can be adjusted for the specific requirements from the driver's seat using the control box. The seeding rate can be quickly and easily adjusted using a metering shutter.

## Features

- Up to 28 metre working width
- Unit weighs 30kg empty
- 105 litre plastic hopper
- Up to 5kg / min max.spread rate (depending on the seed)
- 12v, 25 amp power supply
- Seed wheel set for 2 seeding shafts
- 6 metre cable from the APV unit to the control panel in the tractor cab



# Crane

The German manufactured Duncan Atlas hydraulic cranes are compact, lightweight and effective lifting and loading tools for the safe loading of seed or fertiliser bags into any Duncan seed drill hopper.

Dimensions & Capacities	AKT23A28	AKT33A28
Max. lift capacity (kg)	1800	2350
Reach @ max. lift capacity	1.26	1.36
Stages	3	3
Max. reach (m)	4.2	4.36
Lift capacity @ max. reach (kg)	500	700

## AKT23A28

Weight (kg)	1800	950	650	500
Reach (mm)	1260	2260	3260	4200

## AKT33A28

Weight (kg)	2350	1350	950	700
Reach (mm)	1360	2360	3360	4360



# Popular Accessories



**Rear tow bar** - Solidly built and a must have for towing a roller



**Transport visibility kit** - Lights and high visibility boards for driving on the road



**Bin cameras** - Allows you to monitor the level of seed and fertiliser in the hoppers



**Grease bank kit** - Makes greasing the hard to access grease nipples easy

---

# FROM SEED TO FEED

---

That's the Giltrap Ag difference. From Duncan Drills, the world-best drilling technology, to hard working Giltrap machinery to help you feed, spread and carry, we help take the hard work out of producing some of the world's highest yielding crops and pasture for stock grazing.

**DUNCAN  
TINE DRILLS**



---

**WIDETRAC  
FERTILISER SPREADERS**



---

**PRO-SERIES  
FERTILISER SPREADERS**



---

**ORCHARD SPREADER**



---

**GILTRAP WAGONS**



---

**BUCKTON WAGONS**



---

**SLURRY SPREADERS**



---

**G2 ROUND BALE FEEDER**



---

**G2X2 BALE FEEDER**



---

**BALE BUGGY**



---

**RS2 FEEDER**



---

**MULTIPLUS FEEDERS**



---

**TRAILERS**



---

# GLOBAL PRESENCE, LOCAL KNOWLEDGE

---



We put so much time and energy into bringing you the best possible product that we aren't going to let this stop when the equipment leaves our factory. With a dealer network around the globe we've made sure you'll get the best ongoing equipment support no matter where you are.

---

TO FIND YOUR LOCAL DEALER VISIT  
[GILTRAPAG.CO.NZ/OUR-DEALERS](http://GILTRAPAG.CO.NZ/OUR-DEALERS)

---



**24/7**

**We've assembled a comprehensive dealer network who know what it takes to keep your Giltrap machinery in peak condition. With a blend of local knowledge and engineering expertise our team is here 24/7, so your business doesn't have to stop.**

To find out more about our local dealer network or to discuss your specific needs, contact a member of our team.

**NEW ZEALAND (HEAD OFFICE)**

**TEL** +64 7 873 4199

**EMAIL** [info@giltrapag.co.nz](mailto:info@giltrapag.co.nz)

**[giltrapag.co.nz](http://giltrapag.co.nz)**

**AUSTRALIA**

**TEL** +61 3 9369 6548

**EMAIL** [sales@giltrapag.com.au](mailto:sales@giltrapag.com.au)

**[giltrapag.com.au](http://giltrapag.com.au)**

To find your local Giltrap and Duncan dealer visit  
**[giltrapag.co.nz/our-dealers](http://giltrapag.co.nz/our-dealers)**